



# From WI-FI to LI-FI technology: Which choice to make for a WLAN?

**Bernard KABUATILA Kabuatila<sup>1</sup>, Thierry ILOLO Sady<sup>2</sup>, Théophile MUTANGA Dibeya<sup>3</sup>**

<sup>1,3</sup> Faculty of Computer Science, University Our Lady of Kasayi (U.KA), DRC

<sup>1,2</sup> Faculty of Computer Science, University President Joseph Kasavubu(UKV), Boma, DRC

ARTICLE INFO	ABSTRACT
<b>Published online:</b> 18 October 2024	Today, computer networks make up the basic structure of the seventh continent that is forming before our eyes. Through the immense earthquake that it is generating in this century, the planet is entering a new era. This new continent is that of communication. Made up of networks and traveling at the speed of light, it represents a revolution similar to that of the appearance of writing or the great industrial revolution. These networks, which today completely innervate the planet, are formed thanks to equipment and transmission media. Moreover, thanks to its advantageous characteristics such as user mobility, the computer world prefers networks built on wireless connections instead of wired connections. It is with this in mind that this article is intended to be a detailed study between the two technologies for setting up a wireless local area network (Wifi and LIFI).
<b>Corresponding Author:</b> Bernard Kabuatila	
<b>KEYWORDS:</b> LI-FI, WLAN, WI-FI, LAN, VLC	

## I. INTRODUCTION

Today, computer networks form the basic structure of the seventh continent that is forming before our eyes. Through the immense earthquake that it is generating in this century, the planet is entering a new era. This new continent is that of communication. Made up of networks and traveling at the speed of light, it represents a revolution similar to that of the appearance of writing or the great industrial revolution. These networks, which today completely innervate the planet, are formed thanks to the equipment and transmission support.

Indeed, a transmission medium represents a channel for transporting information from transmission to reception, these media are classified into two families namely: guided links (twisted pair, coaxial cable, optical fiber ) and unguided links (radio wave, hertzian beams and light beams). Depending on the coverage area, computer networks start from personal networks, through local, metropolitan to wide area networks. In this study we focus on local networks.

Moreover, due to its advantageous features such as user mobility, the IT world prefers networks built on wireless connections instead of wired connections.

It is in this perspective that this article is written, which is intended to be a detailed study between the two technologies for setting up a wireless local area network (Wifi and LIFI). The primary objective will be to present the functioning of these two technologies by making a comparative study of the advantages and limitations of each of them in order to fall by

the choice of a technology that we will recommend to the designers of local area networks of companies.

## II. WIRELESS LAN

LANs allow stations to be connected to a digital data network with relatively high data rates and inexpensive connection equipment, both in the public and private sectors. Nowadays, almost every company has an Ethernet-type LAN, i.e. wired. Ethernet (IEEE 802.3 standard) is the most commonly used basic protocol for wired LANs[1].

However, these LANs are dependent on the physical and wired infrastructure of the building, which is a problem for users who seek to be mobile in enterprises. Wireless LANs are particularly in demand by hospitals (patient file management), universities (highly used LANs on campuses), airports, construction sites, factories (production management, stock management, inventories).

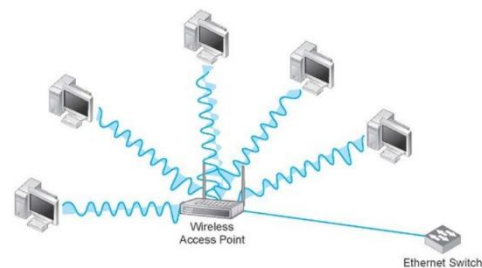

Figure 1: A wireless access point connected into an Ethernet switch

### A. The advantages of WLAN

WLAN has significantly improved the way we work, communicate and access information. Its use cases are multiple.

At home, it has become essential to enjoy high-speed wireless internet connectivity. Almost all of us use it for file sharing, media streaming or communicating via messaging apps or video calls.

Similarly, within companies, WLANs are widely used to provide employees with wireless connectivity. This allows for greater flexibility in choosing the work location, facilitates online meetings and improves collaboration between teams.

In public places such as cafes, airports, hotels and shopping malls, WiFi hotspots are becoming increasingly common. They allow users to connect to the internet for free or for a fee, even while on the move.

Compared to other wired or wireless connectivity technologies, the main advantage of WLAN is mobility since it allows you to connect to the Internet without being tied down by cables in a wide coverage area.

It is also possible to expand a WLAN network to cover larger areas or support a greater number of users by simply adding additional access points.

Another highlight is the support for multiple devices connected simultaneously to a single WLAN access point. This allows users to share a single connection and communicate with each other. These networks are also relatively easy to install and configure, making them accessible to non-technical users. Value for money also contributes to its widespread and accessible adoption.

### B. How WLAN works

Local wireless networks operate using protocols that support radio waves, and the best known is the 802.11 standard, which has also had several versions. Appearing in 1997, the 802.11 standard allowed data transmissions at relatively low speeds, but laid the foundations for what would become the modern WLAN. Over the following years, different standards were developed and succeeded one another to improve performance and functionality[2].

It is worth noting that WiFi, or Wireless Fidelity, refers to a specific technology under the umbrella of the IEEE 802.11 standards, enabling wireless connection to the Internet. On the other hand, WLAN (Wireless Local Area Network) refers to a wireless local area network, encompassing a variety of wireless technologies, including WiFi. So, while every WiFi network is a WLAN, not all WLANs are necessarily WiFi networks. This distinction is crucial to understanding the scope and application of these technologies in our daily lives.

This is why in the following lines we will present, apart from WI-FI technology, another one called LI-FI (Light fidelity) which is a variant of wireless network connections; the objective will be to make a comparative study between the

two technologies to end with a choice of the technology that we can recommend to companies and individuals as we have highlighted in the introduction of this article.

## III. WIFI TECHNOLOGIE

Wi-Fi is a technology that allows multiple computing devices (computer, router, Internet, etc.) to be wirelessly connected within a computer network. This technology is governed by the IEEE 802.11 group of standards, which has given rise to several sub-standards depending on the needs for speed and range [3]:

- ✓ IEEE 802.11 (1990, initial version): It offers a theoretical throughput of 1 to 2 Mbit/s with a range of up to 50m. The frequency range used is the 2.4 GHz band.
- ✓ IEEE 802.11 b (1998, Wi-Fi): is the most widely used currently. It offers a theoretical throughput of 11 Mbit/s (6 Mbit/s actual) with a range of up to 100m. The frequency range used is the 2.4 GHz band.
- ✓ The 802.11a standard (called Wi-Fi 5) provides high throughput (within a radius of 10 meters: 54 Mbit/s theoretical, 27 Mbit/s actual). The 802.11a standard specifies 52 radio subcarrier channels in the 5 GHz frequency band
- ✓ The 802.11g standard is the most widely used standard on the market today. It offers high throughput (54 Mbps theoretical, 25 Mbps actual) on the 2.4 GHz frequency band. The 802.11g standard is backward compatible with the 802.11b standard, which means that equipment that complies with the 802.11g standard can operate in 802.11b.
- ✓ The 802.11n standard has been available since September 11, 2009. The theoretical throughput reaches 300 Mbit/s (actual throughput of 100 Mbit/s within a radius of 100 meters). In April 2006, devices with the 802.11n standard began to appear. 802.11n was designed to be able to use the 2.4 GHz or 5 GHz frequencies. The first 802.11n adapters currently available are generally single-band at 2.4 GHz, but dual-band adapters (2.4 GHz or 5 GHz, your choice) or even dual-radio (2.4 GHz and 5 GHz simultaneously) are also available. Compatible with 802.11 b and g.

### A. How WLAN works

#### ✓ Principle

Unlike wired connections that use wired media to transport data, wireless LAN uses radio waves to transmit data between devices and the network. WLAN works through access points, also called WiFi routers. They establish communication and transmit data between connected devices and the network.

#### ✓ radio wave

“From WI-FI to LI-FI technology: Which choice to make for a WLAN?”

Radio waves are electromagnetic waves, of the same nature as light, that is to say disturbances of the electric and magnetic fields. Unlike sound waves, which need a material support to propagate, electromagnetic waves travel better in a vacuum. And much faster: sound only travels at 300 m/s, while electromagnetic waves travel at nearly 300,000 km/s. They are attenuated or deflected by obstacles, depending on their wavelength, the nature of the material, its shape and its size.

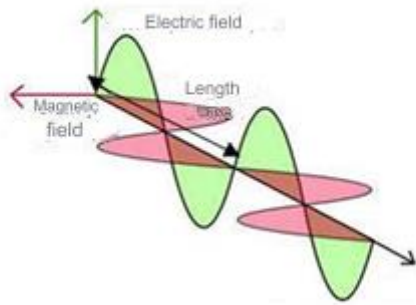

Figure 2: radio wave

This wave is characterized by two physical quantities: Its FREQUENCY, which is the number of oscillations of the electromagnetic field per second (it is measured in Hertz) Its WAVELENGTH, which is, assuming that the electromagnetic field propagates at the speed of light, the distance between two maxima of the electromagnetic field. The following relationship is established between these two values:

$$C = \lambda * \nu$$

C : represents the speed of light, 300,000 Km.sec-1,  
 λ : the wavelength in meters,  
 ν: the frequency in KHz.

✓ *Hertzian spectrum*

WiFi operates at a wavelength of 12.2448cm and a frequency of approximately 2.45Ghz.

✓ *Radio wave propagation - application to wifi*

The following figure shows signal propagation as a function of distance, throughput, and propagation environments.

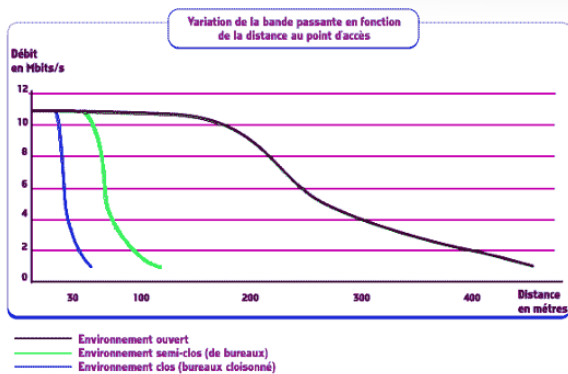

Figure 3: Distance-throughput trade-off

✓ *Calculating the strength of a wifi signal*

To measure both the power of the emitted energy and the sensitivity of reception, milliwatts (mW) or decibels (dB) are used as units of measurement. Decibels have a logarithmic relationship with milliwatts:

$$P \text{ dBm} = 10 \log P \text{ (P is expressed in mW)}$$

The IEEE 802.11 standard offers 2 operating modes:

- ✓ *Infrastructure mode* : where mobile terminals communicate using an access point (base station) and consequently form a BSS (Basic Set Service: basic cell).

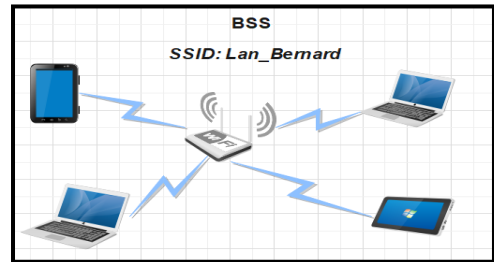

Figure 2: BSS mode

When the network is composed of several BSSs, each of them is connected to a distribution system (DS: Distribution System), via their respective access point (AP). DS often corresponds to a wired Ethernet network (T-Ring, FDDI or wireless: mesh network). This set of BSSs forms an ESS (Extended Set Service).

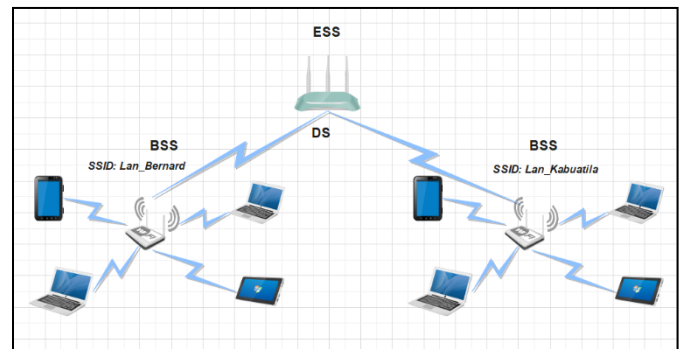

Figure 3: ESS WLAN

- ✓ *Ad Hoc mode (without infrastructure)* : an Ad Hoc network is a set of mobile terminals independent of any infrastructure (access point or connection to the DS), communicating with each other by radio waves, forming an IBSS (Independent BSS), where each of these terminals offers a relay service (router) consisting of accepting a message that is not intended for it in order to retransmit it to another terminal that is out of range of the initial transmitter. The relay service is the fundamental point of Ad Hoc.

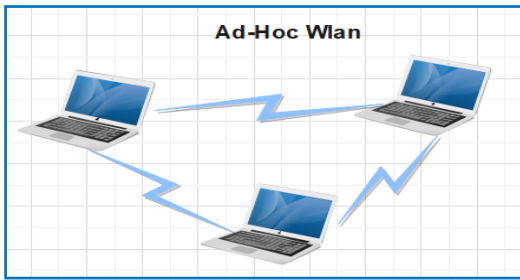

Figure 4 Ad-Hoc Mode

✓ Risk of using wireless network

Waves have the property of propagating in all directions and over a large area. It is almost impossible to limit the propagation of these waves without rendering the service inoperable. As a result, this technology is an open door to listening, even outside buildings. It is therefore essential to secure your network.

IV. LIFI TECHNOLOGIE

Li-Fi is short for " Light Fidelity " Like Wi-Fi, Li-Fi is a wireless communication technology, its particularity is that it uses light to transmit data at high speed . Wi-Fi uses radio waves to do this. Thus, Li-Fi is based on the visible part of the electromagnetic spectrum . Wi-Fi, on the other hand, relies on the non-visible part. This revolutionary technology is part of the VLC family (Visible Light Communications). Li-Fi has a mode of operation similar to Morse code and its pulses. To transmit its signals, Li-Fi needs two main elements, which are a transmitter and a receiver . The emitters materialize in the form of infrared LED bulbs equipped with this technology. The latter produce the optical signal by modulating their intensity, using millions of micro-flickers per second. These variations are so rapid that they cannot be perceived by the human eye.

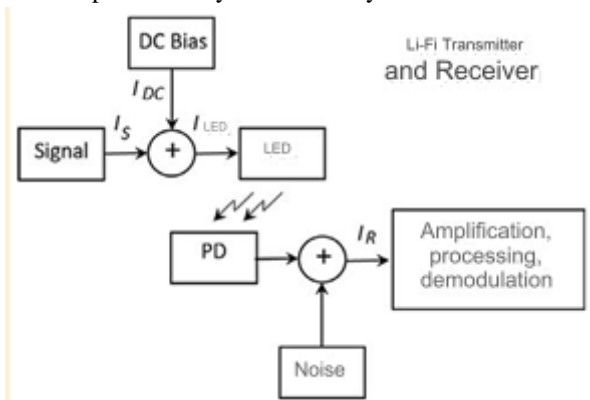

Figure 5 Basic diagram of the Li-Fi system.

Where  $I_{DC}$  : bias current,  $I_S$  : signal current,  $I_{LED}$  : LED supply current,  $I_R$  : signal current.

In practice, here are the different stages of Li-Fi operation:

- ✓ The information is first coded , in order to secure the transmission, which can be easily altered by its environment (the optical channel).

- ✓ This data is then converted into a light signal using an electronic circuit (the Li-Fi router), which is responsible for sending the signal to one or more LEDs. To do this, the light undergoes variations in intensity , depending on what the data to be transmitted requires.
- ✓ Once emitted, the light then propagates through the environment. It undergoes deformations caused in particular by the obstacles it encounters there.
- ✓ After being distorted, the light signal eventually reaches the receiver , which captures it before converting it into an electrical signal.
- ✓ The signal is finally transmitted to the computer or to the device associated with the receiver. The latter then decodes the information, which can then be read.
- ✓ It is possible to equip the transmitting and receiving devices with devices aimed at improving the quality of transmission.

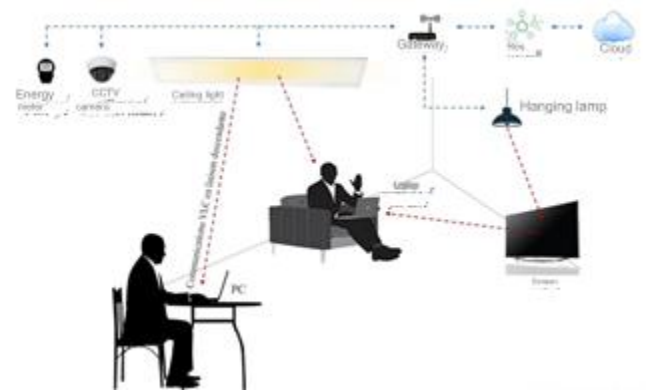

Figure 6 Li-Fi communication diagram

A. the advantages of Li-Fi?

The advantages of this wireless light communication technology are multiple. Which makes it an alternative of choice for the future. Li-Fi provides a solution to various problems[4]:

**Security** : Since light cannot pass through walls, data is transmitted in a relatively restricted area. This makes the exchanges ultra-secure and limits the risks of hacking . Li-Fi represents a good alternative for companies, law firms and government agencies, which are all the more exposed to cyberattacks.

**Speed** : The technology currently offers ultra-fast speeds exceeding Gbit/s . In the long term and with technological advances, Li-Fi could become the most efficient data exchange technology, offering speeds up to 100 times higher than Wi-Fi . On the other hand, the fact that the transmission is limited to a small area guarantees less latency and greater stability .

**Health** : unlike Wi-Fi, Li-Fi does not use electromagnetic waves, and is therefore not harmful to humans . This technology can therefore be presented as a lifesaver in places

that accommodate fragile or sick people, such as hospitals, nursing homes or daycare centers for example.

**No interference** : light waves do not generate any interference. They can therefore be used in areas where the use of Wi-Fi is not desirable: on board aircraft, operating theatres, etc. In addition, the fact that it does not use radio frequencies makes Li-Fi compatible with other wireless communication technologies such as 4G, 5G or Wi-Fi.

**The environment** : the LED bulbs that Li-Fi uses consume 80% less energy than conventional lighting . Indeed, in addition to transmitting data, these lamps can be used for their primary function: lighting. In addition, Li-Fi requires half as much electricity as Wi-Fi hotspots .

#### B. The limits

Firstly, the limitation of Li-Fi is linked to its operating mode: communication is only possible if the light is on. During the day, daylight can interfere with emissions. Secondly, Li-Fi is still unidirectional in most installations today. This means that we can only receive data, it is impossible to emit towards the light source except by coupling it with another technology (PLC, Wifi, etc.). Finally, the use of Li-Fi can only be local, as light does not pass through opaque materials.

#### C. Historical

Men quickly understood that communication via visible light is very useful and practical. Light travels fast and far, it is a good way to propagate information. During the first communications with light, only the human eye could interpret the message sent. We thus find devices such as lighthouses, to communicate the presence of the coast to ship captains. The heliograph was used in the 19th and 20th centuries. This device allowed, thanks to a mirror, to send sunlight in one direction to communicate in Morse code.

Morse code communication with lamps From the end of the 19th century until today, military ships have used searchlights (called Aldis lamps or signal lamps) to communicate. The light signal is used to communicate Morse code between different ships. Originally used as the only means of communication between ships, this device is now used to communicate without radio waves, thus avoiding being picked up by the adversary. This type of communication is also used in aviation to communicate between the control tower of an airport and an aircraft, during radio failures.

The photophone Invented by Alexander Graham Bell, the photophone allowed the sound of the voice to be transmitted by wireless light communication. Thanks to a mirror, sunlight is redirected from one point to another. This mirror is deformable. The sound waves of the voice are sent to this mirror, which is then deformed. The sunlight returned by the mirror is therefore modulated. A parabola is used for reception. It is coupled to a device for converting the light information into electricity and then amplifying the signal. The signal is then used to emit the sound to the user[5].

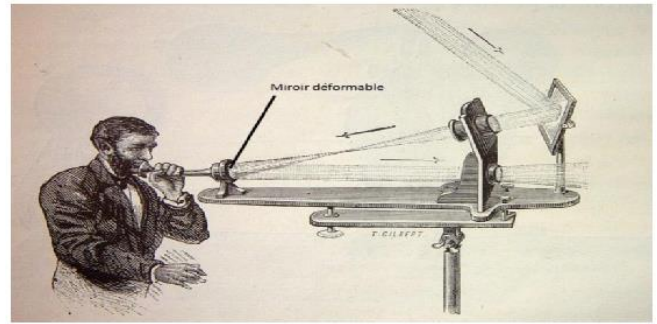

Figure 7 Photophone transmitting device

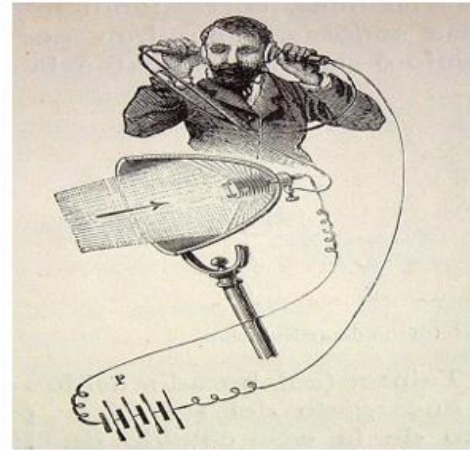

Figure 8 Photophone receiving device

Although the camera phone remained at the working prototype stage, this invention was the first complex use of wireless communication by visible light.

#### D. Computer communication with light waves

Since the 1980s, the main means of long-distance communication in computing has been optical fiber. Information is communicated in the form of light waves (not necessarily visible) modulated in a wire channel: a glass fiber. This means of communication offers very high speeds and low attenuation over distance. This technological advance was made possible by the invention of LEDs and LASERS. Indeed, these technologies make it possible to send a high-frequency light signal (thanks to the short switching time), and to concentrate the light power in a small area, in order to send all the power in the fiber. The technological principle is therefore close to that of Li-Fi, only the transmission channel is different: a glass fiber or ambient air. Bits (0 or 1) are always transmitted by modulating the power of the light source[6].

In August 2011, at a TED conference, Harald Haas, professor at the University of Edinburgh, presented his research on Li-Fi, highlighting the advantages of the technology. He focuses his research on different aspects of a good means of communication: the ability to transmit a lot of information, energy efficiency, availability and security of transmissions. During the conference, he talks about the speeds he has managed to set up with Li-Fi and promises a rapid increase in these speeds to prove the technology's capacity. He then

emphasizes the fact that the LED bulb allows for efficiency and availability. He also presents applications where security is an advantage of Li-Fi: hospitals, aviation, etc.

*E. How Li-Fi works*

Li-Fi or VLC is a wireless communication technology based on the use of visible light between blue (450 nm) and red (760 nm), generated by LEDs. Unlike WiFi which uses the radio part of the electromagnetic spectrum, Li-Fi uses the optical spectrum. The Li-Fi protocol layers are governed by the international standard IEEE 802.15.7 established since 2011 by the IEEE committee. Li-Fi technology is now presented as an alternative to radio frequency (RF) technologies in different application areas and can represent an opportunity especially as the RF spectrum becomes limited in capacity.

*D.1 Transmission techniques used in Li-Fi:*

The system is based on the same principle of transmission in Morse code, it uses LED light to carry digital information, it works at a speed imperceptible to the human eye, the technology transmits data by turning on and off to create a binary stream of 1 and 0, Li-Fi only works with light-emitting diode (LED) bulbs, it will be a real alternative to the electromagnetic waves of Wi-Fi since it is 80% more economical, it can reach a flow rate of 1 Gbit and can be accessed for free. The principle of Li-Fi is to send data by amplitude modulation of light sources according to a well-defined and standardized protocol. It differs from laser communication, optical fiber and IrDa by its protocol layers. The protocol layers of Li-Fi are suitable for wireless communications up to ten meters, slightly more than Bluetooth.

The architecture of an optical link is similar to that of an RF link except that radio waves are replaced by optical waves and antennas are replaced by optoelectronic components. The spectrum of wireless optical communications includes wavelengths ranging from infrared (IR), including visible (VLC), to ultraviolet (UV), a large part of this frequency spectrum is widely used in lighting. What allows this emerging technology to exploit the lighting network is to use it to transmit very high-speed data streams in free space. Using On Off Key (OOK) or PPM (pulse position modulation) coding, the light is switched on and off to send 0s or 1s. The flashing speed is much higher than that perceptible to the human eye. It should be noted that incandescent or halogen light bulbs are not suitable for playing the role of Li-Fi transmitters. Their state switching time is much too slow to allow fast amplitude modulation and therefore to achieve a correct flow rate to transmit information. On the other hand, LEDs, which are semiconductors, are perfectly suited since they allow very high switching frequencies: up to 1,000,000 cycles.

*D.2 General description of a wireless optical communication chain*

The classical model of a wireless optical communication chain is illustrated in Figure 9. The wave transmitted by the transmitter has an instantaneous optical power  $X(t)$ . The wave received by the receiver is translated into instantaneous current  $Y(t)$ .

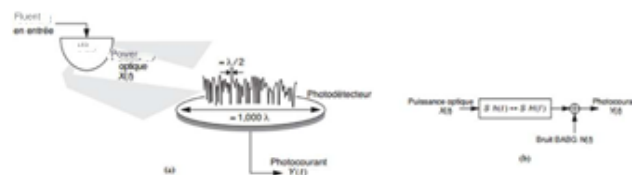

**Figure 9 The wireless optical communication chain**

Note that in optics, the surface area of photodetectors is about a thousand times the wavelength (in general), which creates a spatial diversity that prevents multipath fading[7].

Optical signals can nevertheless be subject to multipath distortions when non-line-of-sight links are used, since the transmitted optical power then propagates via paths of different lengths. The system can be modeled in baseband as illustrated in Figure 7 and by the relation:

$$Y(t) = S \cdot X(t) \otimes h(t) + N(t)$$

The symbol  $\otimes$  represents the convolution and  $S$  is the sensitivity of the detector. Although the general form of the relationship presented is similar to that obtained for radio or electrical systems, the difference is related to the fact that  $X(t)$  represents an instantaneous optical power at the channel input and is therefore always positive.

The average optical power emitted  $P_t$  is given by the relation:

$$P_t = \lim_{T \rightarrow \infty} \frac{1}{2T} \int_{-T}^T X(t) dt$$

The received power required to achieve the desired performance depends on the optical power lost in free space, it is obtained by:

$$P_r = H_0 P_t$$

*D.3 Li-Fi transmitters and receivers*

**Li-Fi Emitters** : Typically it is a diode that converts the electrical signal into optical power, the two main types of diodes used are Light Emitting Diodes (LEDs) and Laser Diodes (LDs). LEDs are commonly used in practice because of their very low cost. Most LEDs have a large emitting surface and therefore often meet eye safety requirements.

The optical radiation of most optical emitters can be modeled by a generalized Lambertian model. An emitter with a generalized Lambertian radiation of order “m” has a radiation pattern expressed by the following relation:

$$R_0(\phi) = \frac{(m+1)}{2\pi} \times \cos^m(\phi)$$

The radiated intensity for an optical power Pt is then written:

$$I_s = P_t R_0(\phi) \quad (\text{W/sr})$$

**LI-FI receivers** : The receiver is a photodetector (photodiode) that converts optical power into an electrical current by detecting the flow of photons incident on the surface of the photodiode. Typically, PIN diodes are used rather than avalanche diodes to limit the impact of noise.

The detection threshold is the minimum received optical power  $P_r$  that can be detected by the photodetector and it is one of the important parameters for the design of the system. The received optical power thus depends on the effective surface of the photodetector  $A_{eff}$ . This surface itself depends on the physical surface of the receiver  $A_{phy}$  and on  $\Psi$  the angle of incidence of the received radiation with respect to the axis of the photodetector. The effective surface can be expressed by the following relation:

$$A_{eff} = \begin{cases} A_{phy} \cos \Psi & 0 \leq \Psi \leq \text{FOV} \\ 0 & \text{autrement} \end{cases}$$

In the relationship, FOV is the field of view of the photodetector, outside this field, the photodetector receives nothing. Increasing the field of view of the Photodetector increases its coverage but also increases the amount of noise received.

#### D.4 Visibility links

In line-of-sight (LOS) links, the receiver directly receives the radiation emitted from the transmitter. Thus, it is necessary that the transmitter and the receiver are in line of sight. However, since the beam emitted by the transmitter is slightly divergent, the receiving cell will only capture a part of the emitted power. In general, in this type of link, only the direct path is considered and therefore it is assumed that the link is not disturbed by the presence of multiple paths. The disadvantage related to the directivity of the beam is that it can easily be subject to cuts or masking due to obstacles between the transmitter and the receiver[8].

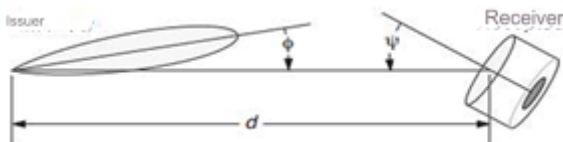

Figure 10 Line-of-sight links

The emitter is assumed to have a radiation intensity  $P_t R_0(\phi)$  (W/sr). At a distance  $d$  and an angle  $\phi$  relative to the emitter normal, the irradiance is:

$$I_r(d, \phi) = P_t R_0(\phi) / d^2$$

The received power  $P_r$  is thus:

$$P_r = I_r(d, \phi) A_{eff}(\Psi)$$

The static gain of the  $H_0$  channel can be obtained by the following expression:

$$H_0 = \begin{cases} \frac{A_{phy}}{d^2} \times \frac{(m+1)}{2\pi} \cos^m \phi \cdot \cos \Psi & 0 \leq \Psi \leq \text{FOV} \\ 0 & \text{autrement} \end{cases}$$

There are generally three main types of line-of-sight links defined as illustrated in Figure 11: fully tracked links, semi-tracked links, and non-tracked links[9].

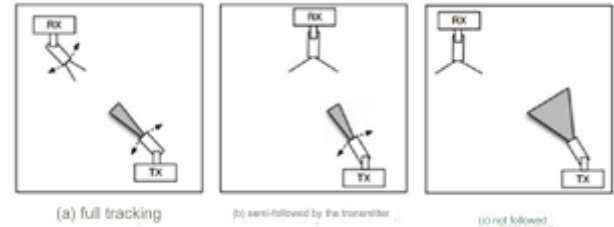

Figure 11 Line-of-sight link types

## V. COMPARISON BETWEEN LI-FI AND WI-FI

In this section, which is the penultimate of our study, we will provide in a table the elements of comparison between the two technologies, in order to come up with the recommendations for the implementation of a reliable WLAN.

Table 1 LI-FI and WI-FI comparison

Characteristic	Wi-Fi	Li-Fi
<b>Transmission medium</b>	Radio waves	Visible light
<b>Speed</b>	Up to several Gbit/s	Potentially up to 100 Gbit/s
<b>Scope</b>	Variable, depends on power and obstacles	Limited to the illuminated area
<b>Security</b>	Vulnerable to interference and hacking	Very secure thanks to range limitation
<b>Cost</b>	Relatively weak, infrastructure widely deployed	Higher, requires specific equipment
<b>Mobility</b>	Good, works anywhere there is a Wi-Fi signal	Limited to the illuminated area

## VI. RECOMMANDATION

From this study we can affirm that each technology has its strengths and weaknesses, so to conclude we think that Wi-Fi technology is Ideal for daily use at home or in the office, for a wide coverage and compatibility with many devices. On the other hand, Li-Fi technology is Perfect for applications requiring extremely high speed and maximum security, such as in industries, hospitals, airplanes, or to create very dense networks (for example, in stadiums).

Li-Fi is a promising technology that could revolutionize wireless communications in the near future. However, Wi-Fi remains the most widespread and convenient solution for most users for now.

The choice of one or the other technology remains motivated by the objectives of the network design (bandwidth, range, services to be deployed, etc.)

## REFERENCES

1. LAN/MAN Standards Committee, IEEE standard for local and metropolitan area networks Part 15.7: Short-Range Wireless Optical Communication Using Visible Light. IEEE (New York) 2018
2. D. Karunatilaka, F. Zafar, V. Kalavally, R. Parthiban, Led based indoor visible light communications: State of the art, IEEE Commun. Surv. Tut., 17 (3), 1649-1678 (2015).
3. J. Green, H. Pérez-Olivas, S. Martínez-Díaz, J. García-Márquez, C. Domínguez-González, R. Santiago-Montero, H. Guan, M. Rozenblat, S. Topsu, VLC-beacon detection with an under-sampled ambient light sensor, Opt. Commun., 397, 122-128 (2017).
4. [4] Wafa SM Elbasher 1, A Comparison between Li-Fi, Wi-Fi, and Ethernet Standards, International Journal of Science and Research (IJSR)ISSN (Online): 2319-70646(2015)
5. <https://www.photoniques.com/articles/photon/abs/2017/03/photon201786p22/photon201786p22.html>
6. J. Green, H. Pérez-Olivas, S. Martínez-Díaz, J. García-Márquez, C. Domínguez-González, R. Santiago-Montero, H. Guan, M. Rozenblat, S. Topsu, VLC -beacon detection with an under-sampled ambient light sensor, Opt. Χομμυν. , 397 , 122-128 (2017).
7. <https://www.abavala.com/en-li-fi-c-lumiere-transporte-l-information/>
8. <https://www.oledcomm.net/fr/blog/actualites/lifi-vs-wifi-les-differences-fondamentales/>
9. <https://fr.slideshare.net/slideshow/comparison-of-lifi-with-wireless-media/85266948>